

Eaton.com

Protective Devices Residual Current Devices PF7









Catalog

EATON

Powering Business Worldwide

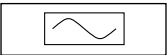
Residual Current Devices - General Data

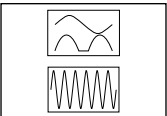
Short description of the most important RCD types

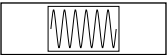
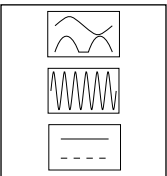
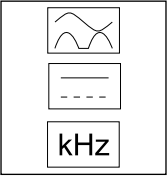
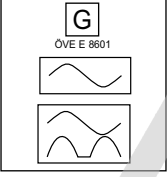
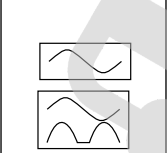
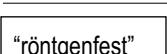
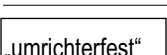
Symbol	Description
	Eaton standard. Suitable for outdoor installation (distribution boxes for outdoor installation and building sites) up to -25° C.
	Conditionally surge-current proof (>250 A, 8/20 μs) for general application.
	Type AC: AC current sensitive RCCB
	Type A: AC and pulsating DC current sensitive RCCB, not affected by smooth DC fault currents up to 6 mA
	Type F: AC and pulsating DC current sensitive RCCB, trips also at frequency mixtures (10 Hz, 50 Hz, 1000 Hz), min. 10 ms time-delayed, min. 3 kA surge current proof, higher load capacity with smooth DC fault currents up to 10 mA
	Frequency range up to 20 kHz
	Trips also at frequency mixtures (10 Hz, 50 Hz, 1000 Hz)
	Type B: All-current sensitive RCD switchgear for applications where DC fault currents may occur. Non-selective, non-delayed. Protection against all kinds of fault currents.
	Type B+: All-current sensitive RCD switchgear for applications where DC fault currents may occur. Non-selective, non-delayed. Protection against all kinds of fault currents. Provides enhanced fire safety.
	RCD of type G (min 10 ms time delay) surge current-proof up to 3 kA. For system components where protection against unwanted tripping is needed to avoid personal injury and damage to property. Also for systems involving long lines with high capacitive reactance. Some versions are sensitive to pulsating DC. Some versions are available in all-current sensitive design.
	RCD of type S (selective, min 40 ms time delay) surge current-proof up to 5 kA. Mainly used as main switch, as well as in combination with surge arresters. This is the only RCD suitable for series connection with other types if the rated tripping current of the downstream RCD does not exceed one third of the rated tripping current of the device of type S. Some versions are sensitive to pulsating DC. Some versions are available in all-current sensitive design.
	„X-ray-proof“, for avoiding unwanted tripping caused by x-ray devices.
	„Frequency converter-proof“, for avoiding unwanted tripping caused by frequency converters, speed-controlled drives, etc.

1.2

Protective Devices

General

Kind of residual current and correct use of RCD Types

Kind of current	Current profile	Correct use / application field of RCCB types						Tripping current
		AC	A	F	B	B+	kHz	
Sinusoidal AC residual current		4	4	4	4			0.5 to 1.0 I _{Dn}
Pulsating DC residual current (positive or negative half-wave)		-	4	4	4			0.35 to 1.4 I _{Dn}
Cut half-wave current		-	4	4	4			Lead angle 90°: to I _{Dn} 1.4
Lead angle 90° el Lead angle 135° el		0.25	4	4	4			Lead angle 135°: 0.11 to 1.4 I _{Dn}
Half-wave with smooth DC current of 6 mA		-	4	4	4			max. 1.4 I _{Dn} + 6 mA
Half-wave with smooth DC current of 10 mA		-	-	4	4			max. 1.4 I _{Dn} + 10 mA
Smooth DC current		-	-	-	4			0.5 to 2.0 I _{Dn}

Tripping time

Break time and non-actuating time for alternating residual currents (r.m.s. values) for type AC and A RCCB

Classification	I _{Dn} mA	I _{Dn}	2 x I _{Dn}	5 x I _{Dn}	5 x I _{Dn} or 0.25A	500A
Standard RCD Conditionally surge current-proof 250 A	≤30	Max. tripping time (s)	0.3	0,15	0,04	0.04
Standard RCD Conditionally surge current-proof 250 A	>30	Max. tripping time (s)	0.3	0.15	0.04	0.04
RCCB Type G (Short-time-delay) Surge current-proof 3 kA	30	Min. non actuating time(s) Max. tripping time (s)	0.01 0.3	0.01 0.15	0.01 0.04	0.01 0.04
RCCB Type G (Short-time-delay) Surge current-proof 3 kA	>30	Min. non actuating time(s) Max. tripping time (s)	0.01 0.3	0.01 0.15	0.01 0.04	0.01 0.04
RCCB Type S (Selective) Surge current-proof 5 kA	>30	Min. non actuating time(s) Max. tripping time (s)	0.13 0.5	0.06 0.2	0.05 0.15	0.04 0.15

Break time for half-wave pulsating residual currents (r.m.s. values) for type A RCCB

Classification	I _{Dn} mA	1.4 x I _{Dn}	2 x I _{Dn}	2.8 x I _{Dn}	4 x I _{Dn}	7 x I _{Dn}	0.35 A	0.5 A	350A
Standard RCD Conditionally surge current-proof 250 A	<30	Max. tripping time (s)	0.3		0.15			0.04	0.04
Standard RCD Conditionally surge current-proof 250 A	30	Max. tripping time (s)	0.3		0.15		0.04		0.04
Standard RCD Conditionally surge current-proof 250 A	>30	Max. tripping time (s)	0.3		0.15		0.04		0.04
RCCB Type G (Short-time-delay) Surge current-proof 3 kA	30	Max. tripping time (s)	0.3		0.15		0.04		0.04
RCCB Type G (Short-time-delay) Surge current-proof 3 kA	>30	Max. tripping time (s)	0.3		0.15		0.04		0.04
RCCB Type S (Selective) Surge current-proof 5 kA	>30	Max. tripping time (s)	0.5		0.2		0.15		0.15

Tripping Characteristics (IEC/EN 61008)

Tripping characteristics, tripping time range and selectivity of instantaneous, surge current-proof „G“ and surge current-proof - selective „S“ residual current devices.

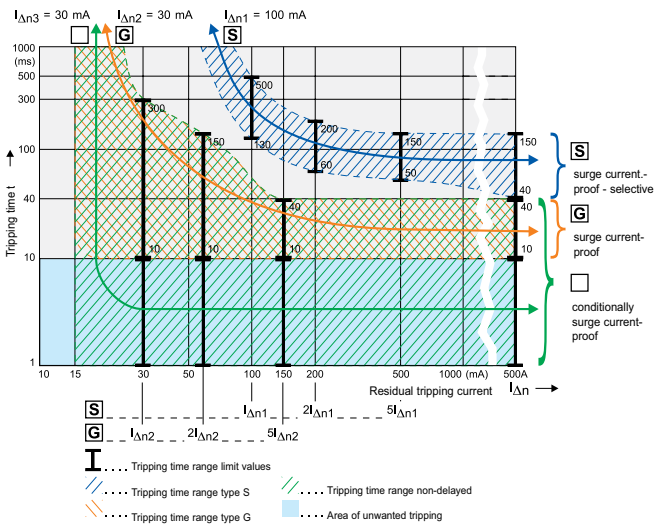

IEC 60364-4-41 deals with **additional protection**: The use of RCDs with a rated residual operating current not exceeding 30 mA, is recognized in a.c. systems as additional protection in the event of failure of the provision for basic protection and/or the provision for fault protection or carelessness by users.

This means when using RCDs for fault current/residual current protection two RCDs must be connected in series.

Testing:

RCDs with tripping time delay (Types -G and -S) may be function tested with conventional testing equipment which must be set according to the instructions for operation of the testing device. Due to reasons inherent in the measuring process, the tripping time determined in this way may be longer than expected in accordance with the specifications of the manufacturer of the measuring instrument.

However, the device is ok if the result of measurement is within the time range specified by the manufacturer of the measuring instrument.

1.4

Protective Devices

General

Hints for the application of our frequency converter-proof RCDs:

Due to the currents flowing off through the filters (designated I_F), the sum of currents through the RCD is not exactly zero, which causes unwanted tripping.

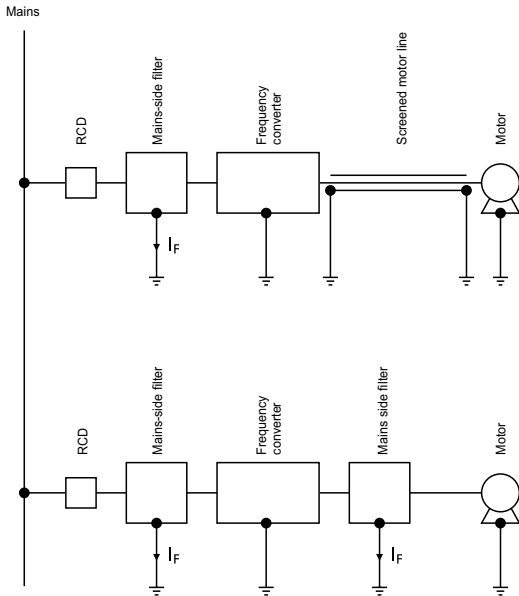

Tripping characteristic

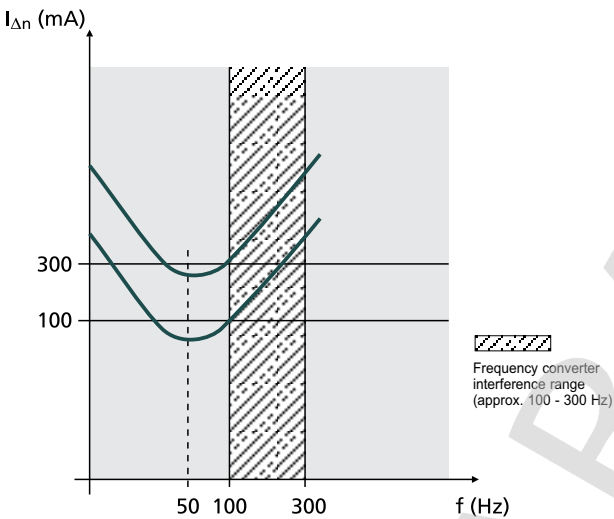

Frequency converters are used in a wide variety of systems and equipment requiring variable speed, such as lifts, escalators, conveyor belts, and large washing machines. Using them for such purposes in circuits with conventional residual current devices causes frequent problems with unwanted tripping.

The technical root cause of this phenomenon is the following: Fast switching operations involving high voltages cause high interference levels which propagate through the lines on the one hand, and in the form of interfering radiation on the other. In order to eliminate this problem, a mains-side filter (also referred to as input filter or EMC-filter) is connected between the RCD and frequency converter. The anti-interference capacitors in the filters produce discharge currents against earth which may cause unwanted tripping of the RCD due to the apparent residual currents. Connecting a filter on the output side between frequency converter and 3-phase AC motor results in the same behaviour.

This sample tripping characteristic of a 100 mA RCD and a 300 mA RCD shows the following: In the frequency range around 50 Hz, the RCDs trip as required (50 - 100 % of the indicated I_{Dn}). In the range shown hatched in the diagram, i. e. from approx. 100 to 300 Hz, unwanted tripping occurs frequently due to the use of frequency converters. Frequency converter-proof residual current devices are much less sensitive in this frequency range than in the 50 - 60 Hz range, which leads to an enormous increase in the reliability of systems.

Therefore, we recommend to use RCDs designed for applications with frequency converter!

These special residual current devices can be recognised by an extension of the type designation („-F“). They meet the requirements of compatibility between RCDs and frequency converters with respect to unwanted tripping.

These are NOT AC/DC-sensitive (IEC 62423) RCDs of type B !!!

Our RCDs of type „-F“ are characterised by SENSITIVITY TO RESIDUAL PULSATING DC and SELECTIVITY or SHORT-TIME DELAY

SG08211



Description

- A complete spectrum of compact residual current devices for a wide range of applications to 100 A
- Rated short-circuit strength 10 kA
- Especially for protection against accidents caused by current and property protection
- Wide variety of types (G, S, A, G/A, S/A, R, U, ...)
- Special type U for frequency converter applications with high surge current proof
- Comprehensive range of accessories can be mounted subsequently
- Frost resistance 

1.6

Protective Devices

xPole

Residual Current Devices PF7

I_n/I_{dN} (A)	Type Designation	Article No.	Units per package
---------------------	---------------------	-------------	----------------------

Type AC

Conditionally surge current-proof 250 A, type AC

SG07411



2-pole

25/0.03	PF7-25/2/003	263577	1/60
25/0.10	PF7-25/2/01	263578	1/60
40/0.03	PF7-40/2/003	263579	1/60
40/0.10	PF7-40/2/01	263580	1/60
63/0.03	PF7-63/2/003	263581	1/60
63/0.10	PF7-63/2/01	263582	1/60
63/0.30	PF7-63/2/03	263583	1/60
100/0.03	PF7-100/2/003	166797	1/60
100/0.10	PF7-100/2/01	166799	1/60
100/0.30	PF7-100/2/03	166822	1/60

SG08211



4-pole

25/0.03	PF7-25/4/003	263584	1/30
25/0.10	PF7-25/4/01	263585	1/30
40/0.03	PF7-40/4/003	263586	1/30
40/0.10	PF7-40/4/01	263587	1/30
40/0.30	PF7-40/4/03	263588	1/30
40/0.50	PF7-40/4/05	263589	1/30
63/0.03	PF7-63/4/003	263590	1/30
63/0.10	PF7-63/4/01	263591	1/30
63/0.30	PF7-63/4/03	263592	1/30
63/0.50	PF7-63/4/05	263593	1/30
80/0.03	PF7-80/4/003	263594	1/30
80/0.10	PF7-80/4/01	263595	1/30
80/0.30	PF7-80/4/03	263596	1/30
80/0.50	PF7-80/4/05	263597	1/30
100/0.03	PF7-100/4/003	102925	1/30
100/0.10	PF7-100/4/01	102926	1/30
100/0.30	PF7-100/4/03	102927	1/30
100/0.50	PF7-100/4/05	102928	1/30

$I_n/I_{\Delta n}$ (A)	Type Designation	Article No.	Units per package
---------------------------	---------------------	-------------	----------------------

Type A

Conditionally surge current-proof 250 A, sensitive to residual pulsating DC, type A

SG07411



2-pole

16/0.01	PF7-16/2/001-A	263598	1/60
25/0.03	PF7-25/2/003-A	263599	1/60
25/0.10	PF7-25/2/01-A	263600	1/60
25/0.30	PF7-25/2/03-A	263601	1/60
40/0.03	PF7-40/2/003-A	263602	1/60
40/0.10	PF7-40/2/01-A	263603	1/60
40/0.30	PF7-40/2/03-A	263604	1/60
63/0.03	PF7-63/2/003-A	263605	1/60
63/0.10	PF7-63/2/01-A	263606	1/60
63/0.30	PF7-63/2/03-A	263607	1/60
100/0.10	PF7-100/2/01-A	166820	1/60
100/0.30	PF7-100/2/03-A	166823	1/60

SG08211



4-pole

25/0.03	PF7-25/4/003-A	263608	1/30
25/0.10	PF7-25/4/01-A	263609	1/30
25/0.30	PF7-25/4/03-A	263610	1/30
40/0.03	PF7-40/4/003-A	263611	1/30
40/0.10	PF7-40/4/01-A	263612	1/30
40/0.30	PF7-40/4/03-A	263613	1/30
63/0.03	PF7-63/4/003-A	263614	1/30
63/0.10	PF7-63/4/01-A	263615	1/30
63/0.30	PF7-63/4/03-A	263616	1/30
80/0.03	PF7-80/4/003-A	263617	1/30
80/0.30	PF7-80/4/03-A	263618	1/30
100/0.03	PF7-100/4/003-A	102929	1/30
100/0.10	PF7-100/4/01-A	102930	1/30
100/0.30	PF7-100/4/03-A	102931	1/30
100/0.50	PF7-100/4/05-A	102932	1/30

1.8

Protective Devices

xPole

Residual Current Devices PF7

I_n/I_{dN} (A)	Type Designation	Article No.	Units per package
---------------------	---------------------	-------------	----------------------

Type G, type G/A

Surge current-proof 3 kA, type G (ÖVE E 8601), type G type G/A

SG07411



2-pole

25/0.03		PF7-25/2/003-G	263619	1/60
25/0.10		PF7-25/2/01-G	263620	1/60
40/0.03		PF7-40/2/003-G	263621	1/60
40/0.10		PF7-40/2/01-G	263622	1/60
40/0.03		PF7-40/2/003-G/A	166826	1/60
63/0.03		PF7-63/2/003-G/A	166827	1/60
80/0.03		PF7-80/2/003-G/A	166828	1/60
100/0.03		PF7-100/2/003-G/A	166798	1/60

SG08211



4-pole

40/0.03		PF7-40/4/003-G	263623	1/30
40/0.10		PF7-40/4/01-G	263624	1/30
63/0.03		PF7-63/4/003-G	263625	1/30
63/0.10		PF7-63/4/01-G	263627	1/30
80/0.03		PF7-80/4/003-G/A	166824	1/30
100/0.03		PF7-100/4/003-G/A	166829	1/30
100/0.3		PF7-100/4/03-G/A	166825	1/30

Type R

Surge current-proof 3 kA, X-ray application, type R

SG08211



4-pole

63/0.03		PF7-63/4/003-R	263628	1/30
100/0.03		PF7-100/4/003-R	102935	1/30

Type S

Selective + surge current-proof 5 kA, type S

SG07411



2-pole

40/0.10		PF7-40/2/01-S	263629	1/60
40/0.30		PF7-40/2/03-S	263630	1/60

SG08211



4-pole

80/0.10		PF7-80/4/01-S	263636	1/30
---------	--	---------------	--------	------

$I_n/I_{\Delta n}$
(A)

Type
Designation

Article No. Units per
package

Type S/A

Selective + surge current-proof 5 kA, sensitive to residual pulsating DC, type S/A

SG08211



4-pole

25/0.10	PF7-25/4/01-S/A	263631	1/30
40/0.10	PF7-40/4/01-S/A	263632	1/30
40/0.30	PF7-40/4/03-S/A	263633	1/30
63/0.10	PF7-63/4/01-S/A	263634	1/30
63/0.30	PF7-63/4/03-S/A	263635	1/30
80/0.30	PF7-80/4/03-S/A	263637	1/30
100/0.30	PF7-100/4/03-S/A	292494	1/30



1.10

Protective Devices

Residual Current Devices PF7

Specifications | Residual Current Devices PF7

Description

- Residual Current Devices
- Shape compatible with and suitable for standard busbar connection to other devices of the P-series
- Twin-purpose terminal (lift/open-mouthed) above and below
- Busbar positioning optionally above or below
- Free terminal space despite installed busbar
- Universal tripping signal switch, also suitable for PL., PFL., Z-A. can be mounted subsequently
- Auxiliary switch Z-HK can be mounted subsequently
- Contact position indicator red - green
- Delayed types suitable for being used with standard fluorescent tubes with or without electronical ballast (30mA-RCD: 30 units per phase conductor, 100mA-RCD: 90 units per phase conductor).
Notes: Depending of the fluorescent lamp ballast manufacturer partly more possible. Symmetrical allocation of the fluorescent lamp ballasts on all phases favourably. Shifting references of the fluorescent lamp ballast manufacturer consider.
- The device functions irrespective of the position of installation
- Tripping is line voltage-independent. Consequently, the RCD is suitable for "fault current/residual current protection" and "additional protection" within the meaning of the applicable installation rules
- Mains connection at either side
- Types with 80 and 100 A permissible short-circuit back-up fuse (PF7-80, PF7-100): Take into account overload protection
- The 4-pole device can also be used for 2- or 3-pole connection. See connection possibilities.
- The test key "T" must be pressed every 6 month. The system operator must be informed of this obligation and his responsibility in a way that can be proven (self-adhesive RCD-label enclosed). The test intervall of 6 month is valid for residential and similar applications. Under all other conditions (e.g. damply or dusty environments), it's recommended to test in shorter intervalls (e.g. monthly).
- Pressing the test key "T" serves the only purpose of function testing the residual current device (RCD). This test does not make earthing resistance measurement or proper checking of the earth conductor condition redundant, which must be performed separately.
- Type -A : Protects against special forms of residual pulsating DC which have not been smoothed.
- Type -G : High reliability against unwanted tripping. Suitable for any circuit where personal injury or damage to property may occur in case of unwanted tripping.
- Type -G/A : Additionally protects against special forms of residual pulsating DC which have not been smoothed Special types for X-ray application PF7-...-R.
- Type -S : Selective residual current device sensitive to AC, type -S. Suitable for systems with surge arresters downstream of the RCD.
- Type -S/A : Additionally protects against special forms of residual pulsating DC which have not been smoothed.

Accessories:

Auxiliary switch for subsequent installation to the left	Z-HK	248432
Tripping signal contact for subsequent installation to the right	Z-NHK	248434
Remote control and automatic switching device	Z-FW/LP	248296
Sealing cover set	Z-RC/AK-2TE	285385
	Z-RC/AK-4 MU	101062

Technical Data

PF7	
Electrical	
Design according to	IEC/EN 61008 Type G according to ÖVE E 8601
Current test marks as printed onto the device	
Tripping	instantaneous
Type G	10 ms delay
Type S	40 ms delay - selective disconnecting function
Rated voltage	U_n 230/400 V AC, 50 Hz
Rated tripping current	I_{Dn} 10, 30, 100, 300, 500 mA
Sensitivity	AC and pulsating DC
Rated insulation voltage	U_i 440 V
Rated impulse withstand voltage	U_{imp} 4 kV (1.2/50 μ s)
Rated short-circuit strength	I_{cn} 10 kA

Maximum back-up fuse PF7

Rating	Fuses	MCB's (Characteristic B/C)
I_n [A]	Short-circuit [A] Overload [A]	Short-circuit [A] Overload [A]
16	63 gG/gI 10 gG/gI	– –
25	63 gG/gI 16 gG/gI	C20 C20
40	63 gG/gI 25 gG/gI	C25 C25
63	63 gG/gI 40 gG/gI	C40 C40
80	80 gG/gI 50 gG/gI	– –
100	100 gG/gI 63 gG/gI	– –

Important: In the case that the maximal possible operating current of the electrical installation don't exceed the rated current of the RCD only short-circuit protection must be implemented. Overload protection must be implemented in the case if the maximal possible operating current of the electrical installation can exceed the rated current of the RCD.

Rated breaking capacity	I_m	
Rated fault breaking capacity	I_{Dm}	
$I_n = 16-40$ A		500 A
$I_n = 63$ A		630 A
$I_n = 80$ A		800 A
$I_n = 100$ A		1000 A

Voltage range of test button	
2-pole	196 - 264 V~
4-pole 30 mA	196 - 264 V~
4-pole 10, 100, 300, 500 mA	196 - 456 V~

Endurance	
electrical components	³ 4,000 switching operations
mechanical components	³ 20,000 switching operations

Mechanical	
Frame size	45 mm
Device height	80 mm
Device width	35 mm (2 MU), 70 mm (4 MU)
Mounting	quick fastening with 2 lock-in positions on DIN rail IEC/EN 60715
Degree of protection, built-in	IP40
Degree of protection in moisture-proof enclosure	IP54
Upper and lower terminals	open-mouthed/lift terminals
Terminal protection	finger and hand touch safe, DGUV VS3, EN 50274
Terminal capacity	1x (1,5 - 35) Φ single wire 2x (1,5 - 16) Φ multi wire
Busbar thickness	0.8 - 2 mm
Operating temperature	-25°C to +40°C
Storage- and transport temperature	-35°C to +60°C
Resistance to climatic conditions	25-55°C/90-95% relative humidity according to IEC 60068-2

Connection diagrams

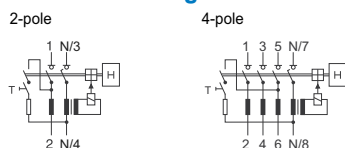

1.12

Protective Devices

Residual Current Devices PF7

Dimensions (mm)

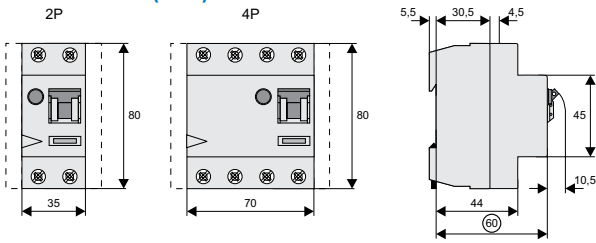

Correct connection

2-pole

30, 100, 300, 500mA types:

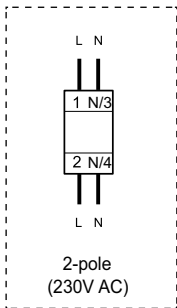

4-pole

30mA types:

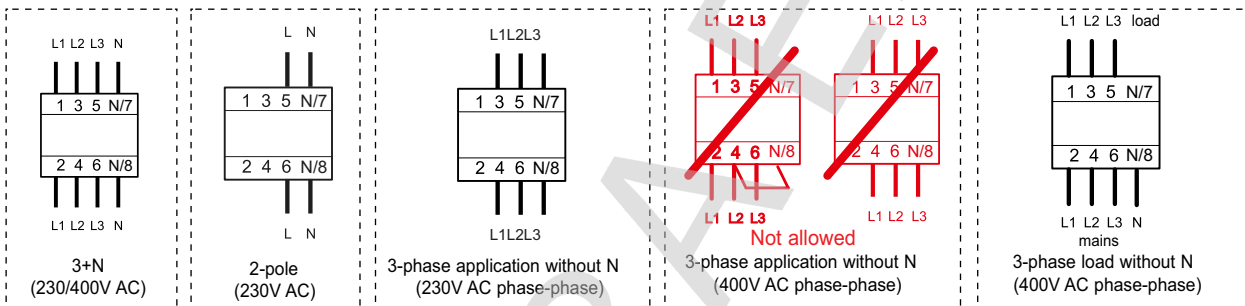

10, 100, 300, 500mA types:

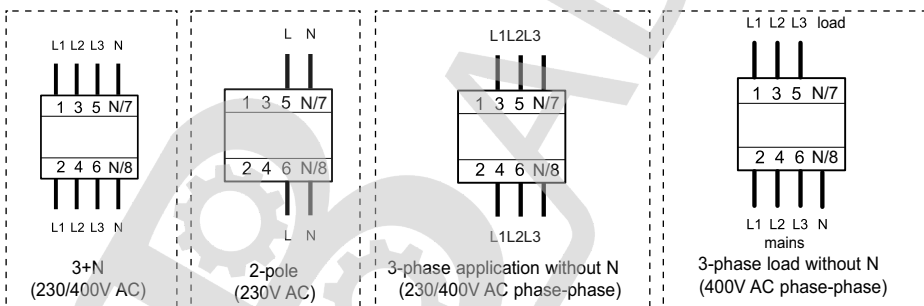

Influence of the ambient temperature to the maximum continuous current (A)

	16A	25A	40A	63A	80A	100A
Ambient temperature	2p	2p	4p	2p	4p	4p
40°	16	25	25	40	40	100
45°	14	21	22	37	37	95
50°	11	18	19	33	34	90
55°	9	14	16	30	31	85
60°	—*)	—*)	—*)	26	27	80

Annotation: It has to be ensured that the values in the table are not exceeded and the back-up fuse/thermal protection works properly.

) not applicable

Eaton's electrical business is a global leader with deep regional application expertise in power distribution and circuit protection; power quality, backup power and energy storage; control and automation; life safety and security; structural solutions; and harsh and hazardous environment solutions. Through end-to-end services, channel and an integrated digital platform & insights Eaton is powering what matters across industries and around the world, helping customers solve their most critical electrical power management challenges.

[Eatonmore](#) information, visit

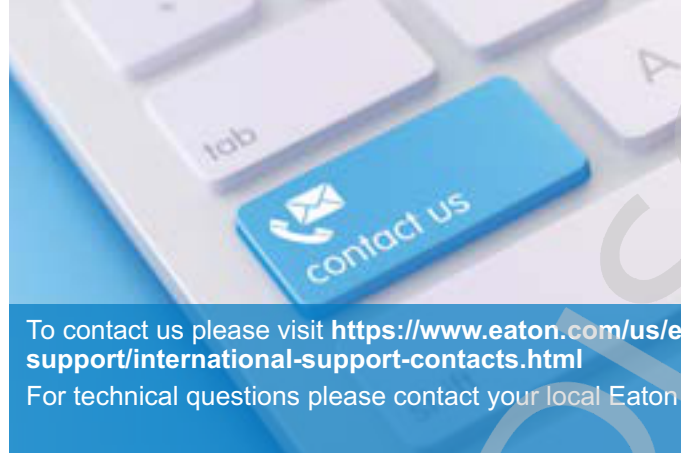
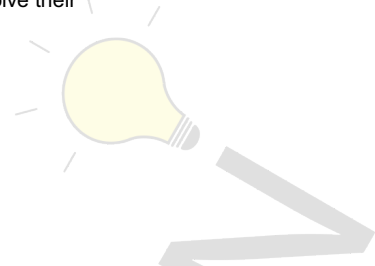

To contact us please visit <https://www.eaton.com/us/en/support/international-support-contacts.html>
For technical questions please contact your local Eaton

Eaton Industries (Austria) GmbH
Scheydgasse 42
1210 Vienna
Austria

Eaton
EMEA Headquarters
Route de la Longeraie 7
1110 Morges, Switzerland
Eaton.eu

© 2020 Eaton
All Rights Reserved
Printed in Austria
Publication No. CA019032EN
Article number 302717-MK
December 2020
Graphics: SRA, Schrems

Changes to the products, to the information contained in this document, and to prices are reserved; as are errors and omissions. Only order confirmations and technical documentation by Eaton is binding. Photos and pictures also do not warrant a specific layout or functionality. Their use in whatever form is subject to prior approval by Eaton. The same applies to trademarks (especially Eaton, Moeller, and Cutler-Hammer). The Terms and Conditions of Eaton apply, as referenced on Eaton Internet pages and Eaton order confirmations.

Eaton is a registered trademark.

All other trademarks are property of their respective owners.

Follow us on social media to get the latest product and support information.

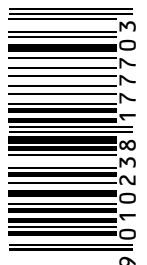

EATON
Powering Business Worldwide